

**客 户 :**

Customer

**客 户 料 号 :**

Customer P/N

**物 料 名 称 :**

Item Name

**感 通 型 号 :** GHFV-AP0630-2R2MS

GanTong P/N

**承 认 书 编 号 :** S23022325

Spec No.

**版 本 号 :** A1

Version No.

制 造 商 Manufacture	
拟 制 Prepared	师高鹏
审 核 Checked	王 康
批 准 Approved	田 一
日 期 Date	2023/2/23

客 户 承 认 Approved by Customer	
批 准 Approved	
日 期 Date	

**备 注:**  
Remark

1. 在使用产品前, 用户必须确认此产品是否适用于自身设计, 感通仅保证产品符合此份承认书的规格。  
Before use, customer should confirm whether this product is suitable for their design, SGTE only ensure products meet this specification.
2. 本承认书的数据更改, 必须经双方确认, 任何一方单独修改无效。  
This specification data change must be confirmed by both parties, any individual modification is in
3. 如客户未回签承认书即下订单, 则视为承认此份承认书。  
If customer placed orders without signing back this specification, it is regarded as recognition.



**1 外形尺寸(mm)**  
Appearance and dimensions

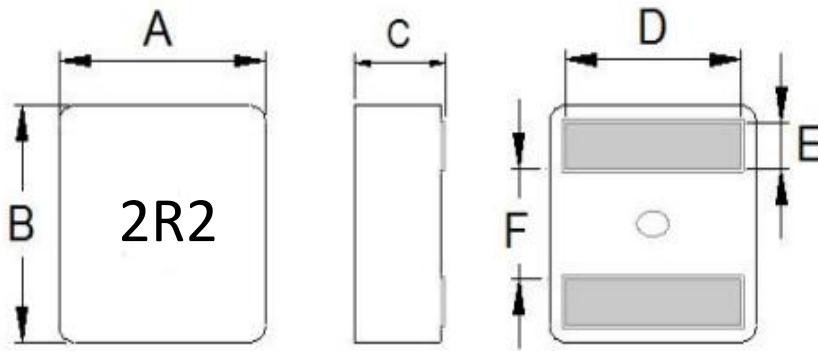

A	B	C	D	E	F
6.6±0.3	6.4±0.3	3.15Max.	5.3 Typ.	1.4±0.3	2.6±0.3

**2 原理图**  
Schematic

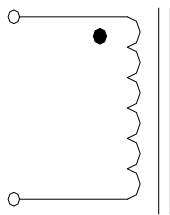

**3 参考基板尺寸(mm)**  
Reference PCB pattern

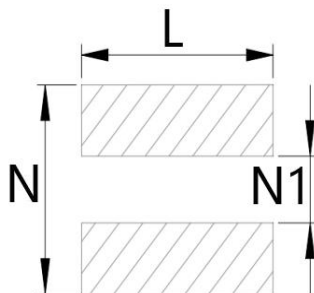

L	5.6	Ref.
N	5.6	Ref.
N1	2.5	Ref.

## 4 电气特性

## Electrical characteristics

型号 Type No.	感值 L	直流电阻 DCR	温升电流 I <sub>rms</sub>	饱和电流 I <sub>sat</sub>
	μH	mΩ	A	A
	±20%	Max.	Max.	Max.
GHFV-AP0630-2R2MS	2.2	12.2	10	15.9

※1 电感值测试条件为100KHZ 0.1V.

Inductance is tested at 100KHZ 0.1V.

※2 温升电流：使产品温度上升到 $\Delta T40^{\circ}\text{C}$ 时所加载的直流电流值( $T_a=25^{\circ}\text{C}$ )。

Heat rating current: The value of DC current when product temperature rise is  $\Delta T40^{\circ}\text{C}$  ( $T_a=25^{\circ}\text{C}$ ).

※3 饱和电流：电感值下降其初始值的40%时所加载的直流电流值。

Saturation current: The value of DC current when the inductance decreases 40% of its initial value.

※4 特别提示：线路设计，组件布局，使用频率，散热系统等均会影响产品温度，请务必验证产品实际发热状况。

Special remind: Circuit design, component placement, frequency, cooling system and etc. all will affect the product temperature. Please verify the actual product temperature in the final application.

※5 所有数据基于环境温度 $25^{\circ}\text{C}$ 条件下测试。

All data is tested on  $25^{\circ}\text{C}$  ambient temperature.

※6 工作温度范围： $-40^{\circ}\text{C} \sim +125^{\circ}\text{C}$ （包含产品发热）

Operating temperature range :  $-40^{\circ}\text{C} \sim +125^{\circ}\text{C}$  (Including self-temperature rise)

**5 包装规格** (Dimensions in mm)

**Packaging specification**

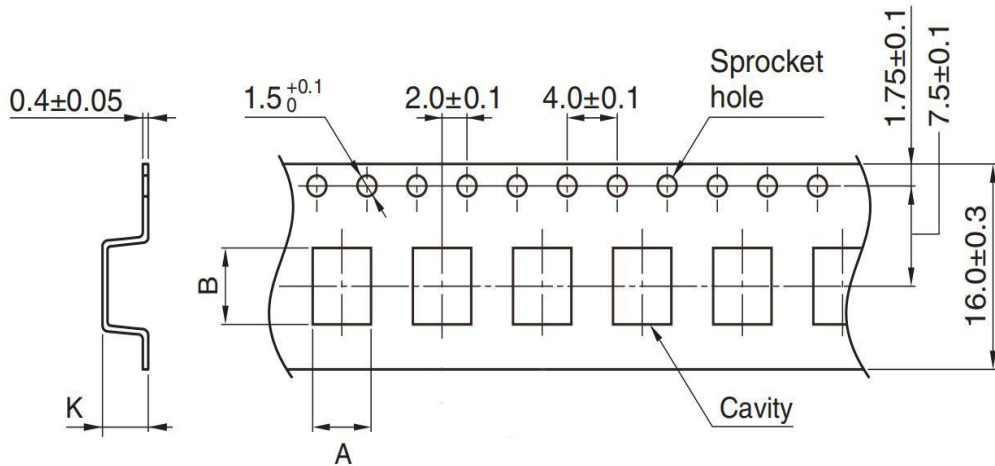
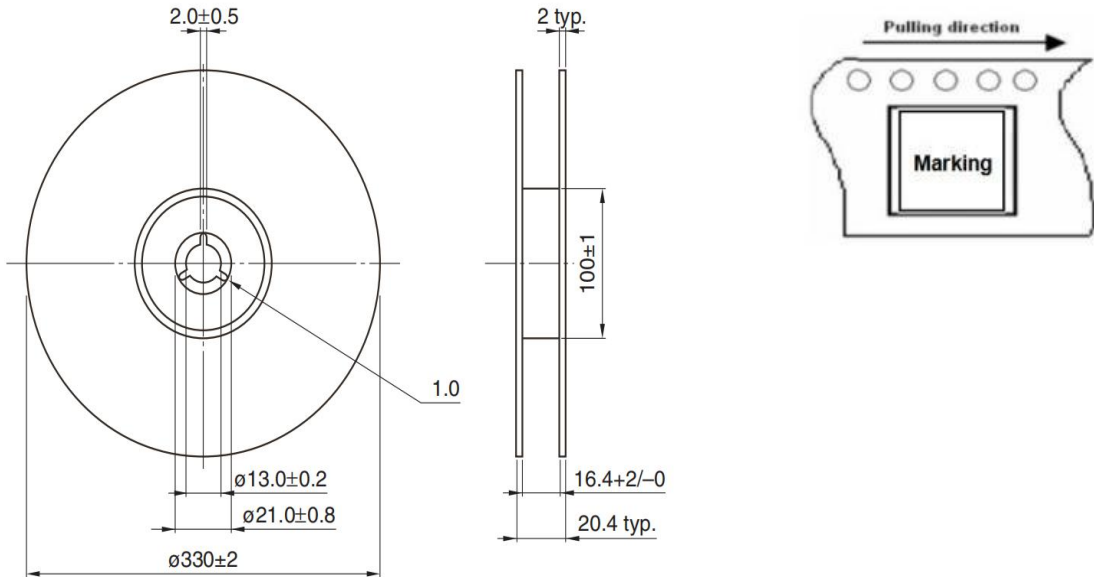

Dimensions in mm

A	B	K
7.0 Ref.	6.9 Ref.	3.2 Ref.

**1000 pcs/reel**

6 回流焊接规范

Reflow soldering specification

6.1 SMT回流焊温度曲线

Reflow profile for SMT components

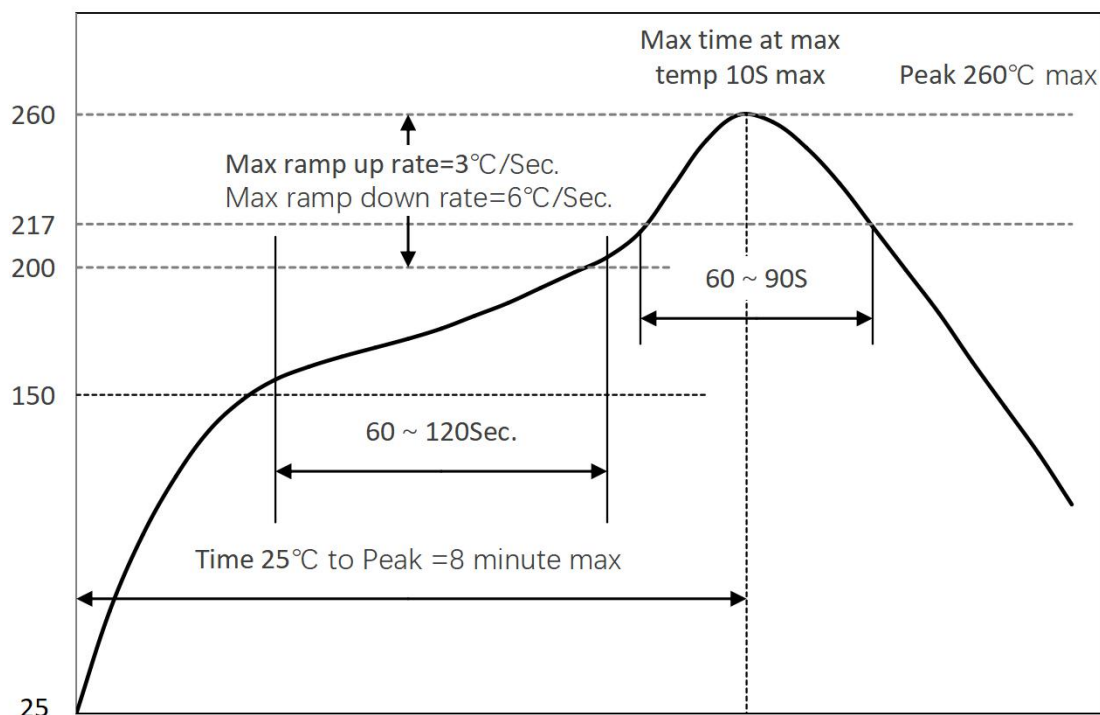

6.2 封装体积与峰值温度(TP)关系分类

Classification of peak package body temperature (TP)

无铅装配 PB-Free Assembly	封装厚度 Package Thickness	封装体积 Package Volume		
		<350 mm <sup>3</sup>	350~2000 mm <sup>3</sup>	>2000 mm <sup>3</sup>
	<1.6mm	260°C	260°C	260°C
	1.6~2.5mm	260°C	250°C	245°C
	≥2.5mm	250°C	245°C	245°C

※回流焊参照标准IPC/JEDEC J-STD-020D。

Reflow is referred to standard IPC/JEDEC J-STD-020D.

6.3 烙铁焊接: 温度350°C± 10°C, 焊接时间3S以内。

Iron soldering: temperature 350°C± 10°C, dwell time shall be less than 3S.

## 7 可靠性试验

### Reliability test

#### 7.1 端子强度试验

##### Terminal Strength test

将样品焊接到基板上，在X和Y方向上各加5.0N的推力10秒钟，无电极剥离现象发生。  
No electrode detachment should be found when the device is pushed in two directions of X and Y with the force of 5N for 10 second.

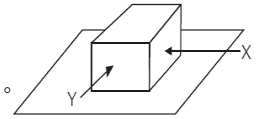

#### 7.2 可焊性试验

##### Solderability test

样品经过(160±10℃, 90秒)预处理，再浸入到常温的助焊剂中5秒，之后将样品电极浸没到锡炉(245±5℃, 3±1秒)，拿出确认电极面上锡状态：电极面被新锡覆盖超过90%。  
After preheat(160±10℃, 90 sec), then the specimen shall be immersed in flux at room temperature, later be immersed in solder pot (245±5℃, 3±1sec), take out and confirm the soldering state. Electrode has been covered by new solder more than 90%.

#### 7.3 冲击试验

##### Shock test

根据橡胶式落下冲击试验机，在互相垂直的3个不同方向，冲击加速度为981m/s<sup>2</sup> (100G)，落下后，对比电感值的变化率在初始值的±15%以内。  
Inductance deviation within ±15% of initial value, after being dropped once with 981m/s<sup>2</sup> (100G) attitude upon a rubber block method shock testing machine, in three different orientations.

#### 7.4 耐湿试验

##### Humidity test

在温度85±3℃和湿度80~85%环境中保存96±4小时后，拿出来用干布擦去水滴，在常温常湿下放置1小时后，对比电感值的变化率在初始值的±15%以内。  
Inductance deviation within ±15% of initial value, after 96±4 hours in 80~85% relative humidity at 85±3℃ and 1 hour drying under normal condition.

#### 7.5 低温保存试验

##### Low temperature storage test

在温度-40±3℃环境中保存96±4小时后，在室温下放置1-2小时对比电感值的变化率在初始值的±15%以内。  
The specimen shall be stored in a chamber of temperature -40±3℃ for 96±4 hours, and then it shall be subjected to standard atmosphere conditions for 1-2 hours. The inductance deviation within ±15% of initial value.

#### 7.6 高温保存试验

##### High temperature storage test

在温度125±3℃环境中保存96±4小时后，放置室温下1-2小时，对比电感值的变化率在初始值的±15%以内。  
The specimen shall be stored in a chamber of temperature 125±3℃ for 96±4 hours, and then it shall be subjected to standard atmosphere conditions for 1-2 hours. The inductance deviation within±15% of initial value.

#### 7.7 冷热冲击试验

##### Temperature cycle test

在-40±3℃环境中放置30分钟，之后在转移到125±3℃环境中放置30分钟(转移时间不超过2分钟)，这为一个循环，在循环100次以后，对比电感值的变化率在初始值的±15%以内。  
Being subjected to -40±3℃ for 30 minutes, then to 125±3℃ for 30 minutes (Transition time with 2 minutes). This constitutes one cycle. The inductance deviation within ±15% of initial value.

## 8 注意事项 Notes

- 8.1 产品最佳安装保质期限：12个月(从制造日期开始计算)  
保存条件：密封包装，温度 $\leq 40^{\circ}\text{C}$ ，相对湿度 $\leq 70\%$ 。  
The best assembly quality guarantee period of product : 12 months (From manufacture date),  
Storage condition : seal in packaging, temperature $\leq 40^{\circ}\text{C}$ , RH $\leq 70\%$ .
- 8.2 如果取出使用，剩余产品请用胶袋密封，按照以上条件保存，避免电极氧化，影响焊接状态。  
If taking out for use, the remaining products should be sealed in plastic bags and preserved  
in accordance with the above conditions, to avoid oxidation of electrodes and affect soldering status.
- 8.3 请不要将产品保存于高温、高湿、有尘埃、腐蚀性气体的不适合环境中。  
Do not keep products in unsuitable storage conditions,  
such as areas susceptible to high temperature, high humidity, dust or corrosion.
- 8.4 请小心轻放，避免由于产品跌落或取出不当导致产品损坏。  
Always handle products with care to avoid damage.
- 8.5 手上的油脂会导致产品的可焊性降低，请避免直接用手接触产品的端子，以保证最佳的可焊性。  
Do not touch electrodes with bare hands directly, as oil secretions may inhibit soldering.  
Always ensure optimum conditions for soldering.
- 8.6 当本产品应用到相似或新的项目时，电性可能因使用条件的不同而与规格产生一定的出入。  
When product will be used on a similar or new project to the original one,  
sometimes it might be unable to satisfy the specification due to different condition of usage.
- 8.7 本产品无任何自我保护功能，请勿在过载、高温、高压等不正常条件下使用。  
This product itself does not have any protective function in abnormal conditions,  
such as overload, high temperature, high voltage and etc.
- 8.8 超规格的高电压绝缘测试会对本产品绝缘金属粉体造成损伤，从而缩短产品的使用寿命。  
Hi-Pot test with higher voltage than spec value will damage insulation material and shorten its life.
- 8.9 如果将本产品用于埋置复合组件，有可能会对本产品表面造成腐蚀，请咨询本公司。  
If using in potting compound, the product might be damaged, please consult with us.
- 8.10 请不要清洗本产品，如果需要清洗，请咨询本公司。  
Please do not clean this product. If necessary, please consult with us.